

MODEL **CHV-5X** HF Multi-band Rotatable Dipole  
for 7,14,21,28,50 MHz

Instruction Manual

Thank you for purchasing our products.

**For your safety :**  
Read this manual carefully for proper handling and operation before using.  
Keep this manual in a safe place for future reference.

★ Check all parts are included before assembling, according to the parts list on the next page.

**[ Features ]**

- ◆ Easily assembled in "V", Ground-Plane or horizontal configuration
- ◆ Excellent weather-resistance and heavy-duty antenna
- ◆ Easy to adjust frequency with wideband Balun

**[ Specifications ]**

- Freq.Band : 7,14,21,28,50MHz / 5 Band
- Antenna Type : Center loading half wave dipole
- Gain : approx. 2.15dBi
- Max Power : 150 W(SSB) [7/14MHz],  
220 W(SSB) [21/28/50MHz]
- VSWR : 1.5 or less (at center freq. each band)
- Impedance : 50Ω
- Connector : M-J (SO-239) type
- Mounting Mast Diameter : Φ25~62mm
- Max Wind Survival : 30m/sec
- Horizontal Length : approx. 4.0m
- Weight : approx. 2.7kg (each element :  
approx.0.9kg)

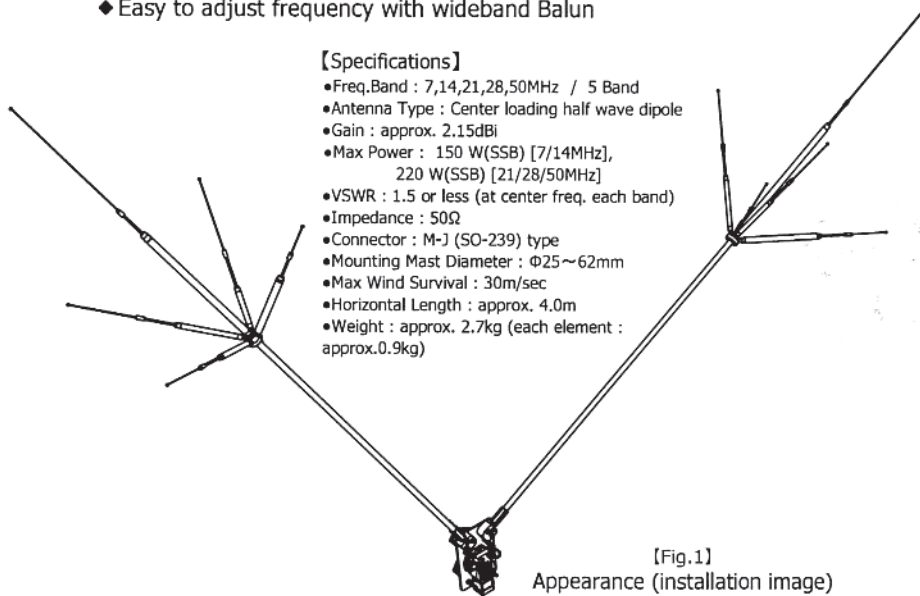

{Fig.1}  
Appearance (installation image)

**Warning** Warnings must be followed carefully to avoid serious bodily injury.

**Caution** Cautions must be observed to avoid minor injury to your self or damage to your equipment.

**Warning** you might be killed or injured if you don't follow the below instructions.

- ① Choose a safe place to erect this antenna, complying with the laws and regulations in your country.
- ② Choose a calm, dry day to erect the antenna.
- ③ Do not erect this antenna while lightning.
- ④ Do not touch the antenna while transmitting.
- ⑤ Do not erect this antenna near any electric wires and street lamps.
- ⑥ Make sure to tighten the screws, nuts and bolts securely. Otherwise the antenna falls very easily.
- ⑦ Be careful not to drop down any tools or screws when mounting this antenna on a high place.
- ⑧ Fix the coax cable securely, otherwise this antenna could be collapsed by heavy wind.

**Parts List**

	Parts name	Qty.
	Feeding section (partially-preassembled)	1set
1	Balun CBL-2500 (preinstalled to feeding section)	1
	Feed wire (with crimp-type terminal on both ends)	2
2	Aluminum element pipe Assy.	2
3	7MHz element (with spring washer)	2
4	14MHz element (with spring washer)	2
5	21MHz element (with spring washer)	2
6	28MHz element (with spring washer)	2
7	50MHz element (with spring washer)	2
8	U-Bolt · Mount Bracket with spring washer & Hex-nut for M6	2sets
9	Self-fusing tape (20cm)	1
10	Hex-key wrench (2mm)	1

**⚠ PRECAUTIONS for Installation**

- Always wear a safety hat and a life line when you mount this antenna on a high place, such as roof top.
- Check if the Cable Connector fits into this antenna.
- Be sure to tighten all screws, nuts and bolts to prevent them from coming loose by vehicle vibration or earthquake.
- Do not erect this antenna near any overhead wires, steel towers, buildings or any other obstacles. Otherwise, SWR could be higher or cause significant performance degradation.
- Waterproofing is highly recommended, especially for long-term use.

**[Fig.2]**  
Installation mount bracket

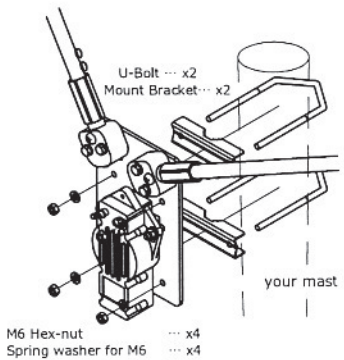

**[How to assemble]**

1. Rotate the resin spacers to degrees you want to point this antenna. Refer to fig.6 "Element Rotatable Range" on next page.
2. Attach 2 brackets to the other side of Balun CBL-2500, as shown in the left fig. Then, fix it to your mast(25 – 60mm). Be sure to tighten the nuts securely.
3. Attach each element to the aluminum pipe Assy, as shown in fig.4. 7MHz Element should be center, others obliquely attached wherever you like.
4. Attach the assembled elements to the feeding section at the bottom. Refer to the Fig.5 on the next page. Be sure to tighten all bolts and nuts securely so that the elements are not be bumped.
5. Put 50 coax cable with M-P(PL-259) connector(not included) into Balun, as shown in fig.3.
6. Waterproof connectors with the self-fusing tape.

■ Stretch the self-fusing tape 1.5 times longer and wrap it around connectors. Then, waterproof it with vinyl tape to keep weathering resistance.

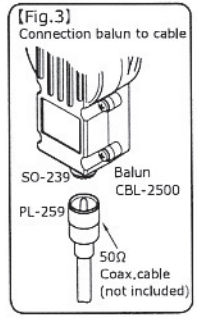

**[Fig.4]**  
Assembly drawing of the elements

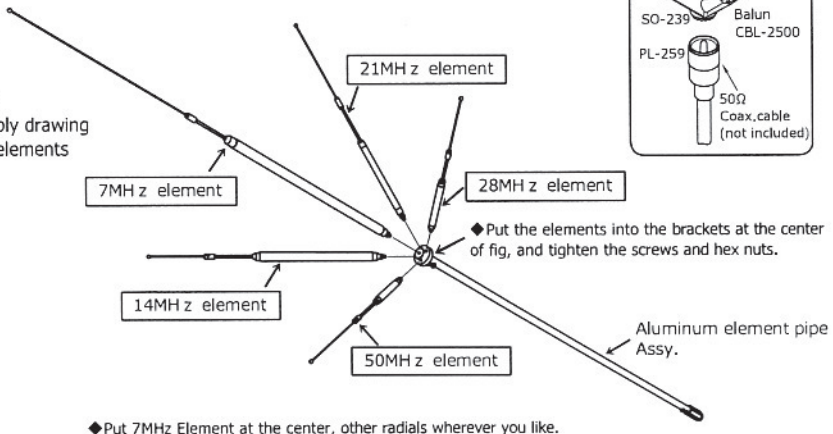

[Fig.5]  
Fixing the bottom of the elements

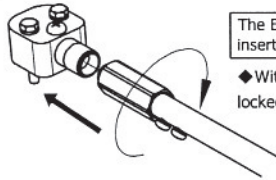

The Elements should be straightly inserted and fixed with hex-fittings.

◆ With the element obliquely-inserted, the screws are not appropriately locked so that the elements can be bumped.

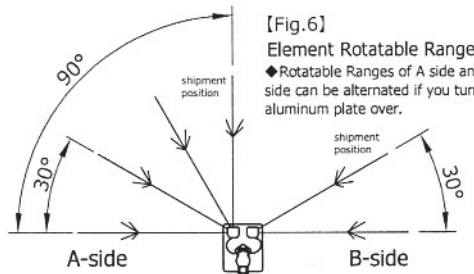

[Fig.6]  
Element Rotatable Range  
◆ Rotatable Ranges of A side and B side can be alternated if you turn the aluminum plate over.

■ Element Rotatable Range  
A-side element : Elevation 0~90° 30° pitch / 4 directions  
B-side element : Elevation 0~30° 2 directions

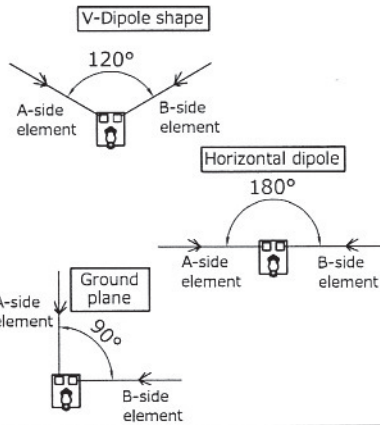

**[Operating Procedure]**

★ Start tuning VSWR at 7MHz, then, followed by 18, 21, 28, 50MHz.

1. Check VSWR with SWR meter etc. SWR should be 1.5 or less.  
Always check VSWR with the minimum power of your SWR meter.

2. Adjust the top element length when the resonant frequency not matching.  
The longer the element is, the resonant freq becomes low.  
The shorter the element is, the resonant freq becomes high.

When you want to shorten the length more than variable length limit, you can cut the top element. However, please note that the length won't be enough when you adjust the direction to extend.

★ both top elements are the same in length, but you can adjust the one 10mm longer, and the other 10mm shorter.



3. Start operating if VSWR is normal.

Correspondence Table for the basic element L length

Table for basis length L of element

	L (mm)	fo Set frequency	Frequency change per 1cm (reference data)
7MHz element	360	7.07 MHz	42 kHz/cm
14MHz element	20	14.2 MHz	150 kHz/cm
21MHz element	160	21.1 MHz	190 kHz/cm
28MHz element	80	28.6 MHz	300 kHz/cm
50MHz element	125	51.2 MHz	420 kHz/cm

Note 1. The frequency change per 1cm is determined by changing 1cm each of both elements.

Note 2. 50MHz band can't be covered by adjusting the top element length only. Cutting element or using the antenna tuner is highly recommended.

■ Fine-tune the length of each element ends and/or the angle of the elements, according to installation environment.

◆ VSWR Reference data

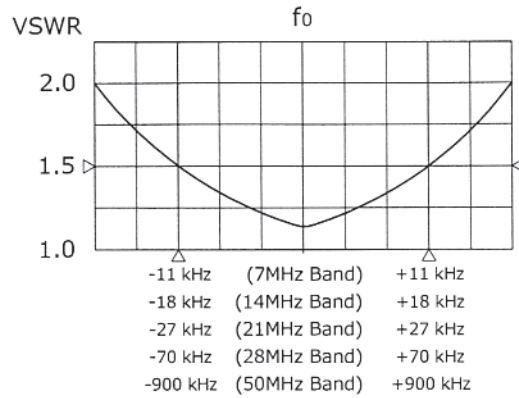

◆ Target VSWR is 1.5 or less

Troubleshooting	
<u>Q.VSWR is high</u>	Ans1. Surrounding environment, such as buildings, obstacles or ground height etc, can affect VSWR. Try to change the element angle or position. Be sure not to lose or drop the nuts when changing the angle. Ans2. Lightning can damage the antenna. Check the antenna after lightning storms. Ans3. Resonance Frequency can be drifted by rain, wind or snow etc. Always check VSWR before and while operation.
<u>Q. 7MHz (or other band) Element can be removed?</u>	Ans. All elements should always be attached while operation. We can not guarantee that the antenna will perfectly work if any of the elements removed.
<u>Q.The element of other products(COMET UHV-6, HV-R etc) can be available?</u>	Ans. Do not use other elements for this antenna. Also do not use the elements of CHV-5X for other products, they are for CHV-5x only.

⚠ Precautions for operation
<ul style="list-style-type: none"> <li>•Do not touch the antenna while transmitting, otherwise you would get burned.</li> <li>•Do not touch the antenna or coax cables while lightning. Checking SWR after lightning is highly recommended.</li> <li>•Do not use this antenna outside its specification. Failure to follow this would damage the antenna.</li> <li>•Make sure to adjust the antenna in a right way. Higher SWR could cause the performance degradation.</li> <li>•Never attempt to fix or modify this antenna by yourself.</li> </ul>

【After-Sales Service】
<p>We provide the replacement parts for the damages by unintentional accidents or for deterioration with long-term use. Please ask the local shop you purchased this product.</p> <p>This product is made under the stringent quality control. Should there be any breakage in transit, please do not hesitate to contact the shop you purchased this product.</p>

【Maintenance】
<p>★If any unusual situation happens, stop using immediately and ask the local shop you purchased this product. Confirm if the product works normally before operating.</p> <p>Be sure to change the parts which have strength poverty or deformation across the ages etc.</p>

■ Specifications or appearance is subject to change without notice.